



► **Instruction & Installation Manual**

# Hydraulic-to-Bolt Conversion Kit

# Contents

Contacting Us .....	3
<b>Parts List &amp; Diagram</b>	
Hydraulic-to-Bolt Conversion Kit Complete Parts List .....	4
<b>Trim Tab Overview &amp; Operation</b>	
How Trim Tabs Work .....	5
Special Conditions & Safety .....	7
<b>Installation Instructions</b>	
Compatibility .....	9
Planning the Installation .....	10
Removing the Pump .....	10
Removing the Hydraulic Actuators .....	11
Installing New Bennett Electric Actuators .....	12
Installing the Relay Module .....	16
Testing & Troubleshooting .....	17
<b>Warranty</b>	
Limited Warranty .....	20
Warranty Period .....	21

# Congratulations

You've just made an investment in the most durable and reliable electric trim tab system in the world! Installing a set of Bennett trim tabs on your boat will give you better visibility, increased fuel efficiency, and a smoother, more comfortable ride for everyone on board. Get Bennett on board and **enjoy the ride!**

## Bennett Marine—Behind You For The Long Run

Bennett's legendary customer service and support is a priceless perk to your new purchase! Our expert staff with over 50 years of trim tab experience is ready to assist with your installation, help with troubleshooting, or answer any of your questions.

## How to Contact Us

Call us at 1-954-427-1400, email [Info@BennettTrimTabs.com](mailto:Info@BennettTrimTabs.com), or go to [BennettTrimTabs.com/Contact](http://BennettTrimTabs.com/Contact) and fill out the online form. Please allow 24 hours for online requests. Our office hours are Monday through Friday from 8:00 a.m. to 5:00 p.m. (Eastern Standard Time).

## The Benefits of Trim Tabs

### **Increase Visibility For A Safer Ride**

Keeping your bow down at reduced speeds is important, especially in congested waters or foul weather. Bennett trim tabs enable you to plane at a much lower speed, operating your boat more safely.

### **Save Money With Better Fuel Efficiency**

Getting up on plane quicker means your boat spends less time running inefficiently. Bennett trim tabs decrease engine laboring, dramatically improving your fuel economy and prolonging the life of the engine.

### **Maximize Performance While Smoothing Out The Ride**

Bennett trim tabs enhance the operating economy of your boat by lifting the stern in proportion to speed, weight distribution, and fuel load changes.

# Parts List & Diagram

## Hydraulic-to-Bolt Conversion Kit

HYDBOLTCON

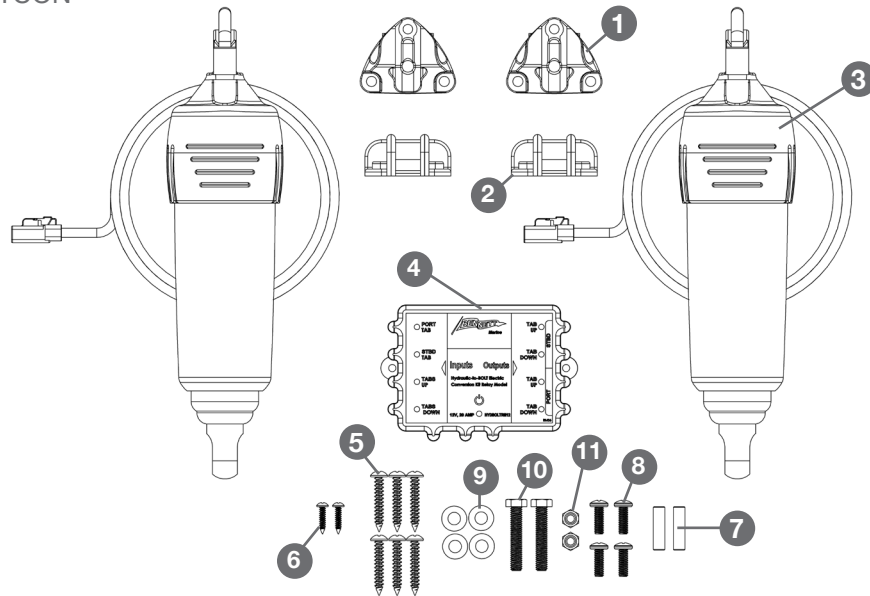

PART	PART NO.	QTY.
1 Adjustable Upper Hinge Mount	BQE82	2
2 Lower Hinge Mount	ACT1	2
3 Bolt Actuator Assembly	BEA3000	2
4 Hydraulic To Bolt Conversion Relay Module	RMCON	1
5 #14 X 1-1/2" Stainless Steel Screw	HP2	6
6 #8 X 3/4" Stainless Steel Screw	ML63	2
7 5/16 X 1-3/16 Stainless Steel Dowel Pin	BXA47-2	2
8 1/4-20 x 3/4" Stainless Steel Screw	HP3	4
9 5/16 Flat Washers	ML328	4
10 Hex Head Bolt 5/16-18 x 1-3/4 Lg, 18-8 SS	ML432	2
11 5/16-18 Nylock Hex Nut	ML326	2

*Material provided for two actuators*

# Trim Tab Overview & Operation

## How Trim Tabs Work

Bennett trim tabs most often attach to the bottom edge of the transom (although other mounting variations are available). When the helm control is pressed, the trim tabs move into position. Water-force on the trim tab creates upward pressure, raising the stern and lowering the bow. Properly sized trim tabs improve the performance of your boat in a wide range of weight, weather and water conditions.

In general, trim tabs operate in reverse of what you may think (Figure 1). The port (left) trim tab controls the starboard (right) bow. Conversely, the starboard (right) trim tab controls the port (left) bow. The helm control is wired so that all you have to do is press the control in the direction you want the bow to move. Don't worry about which trim tab is moving. The proper use of Bennett Trim Tabs becomes second nature after a short time.

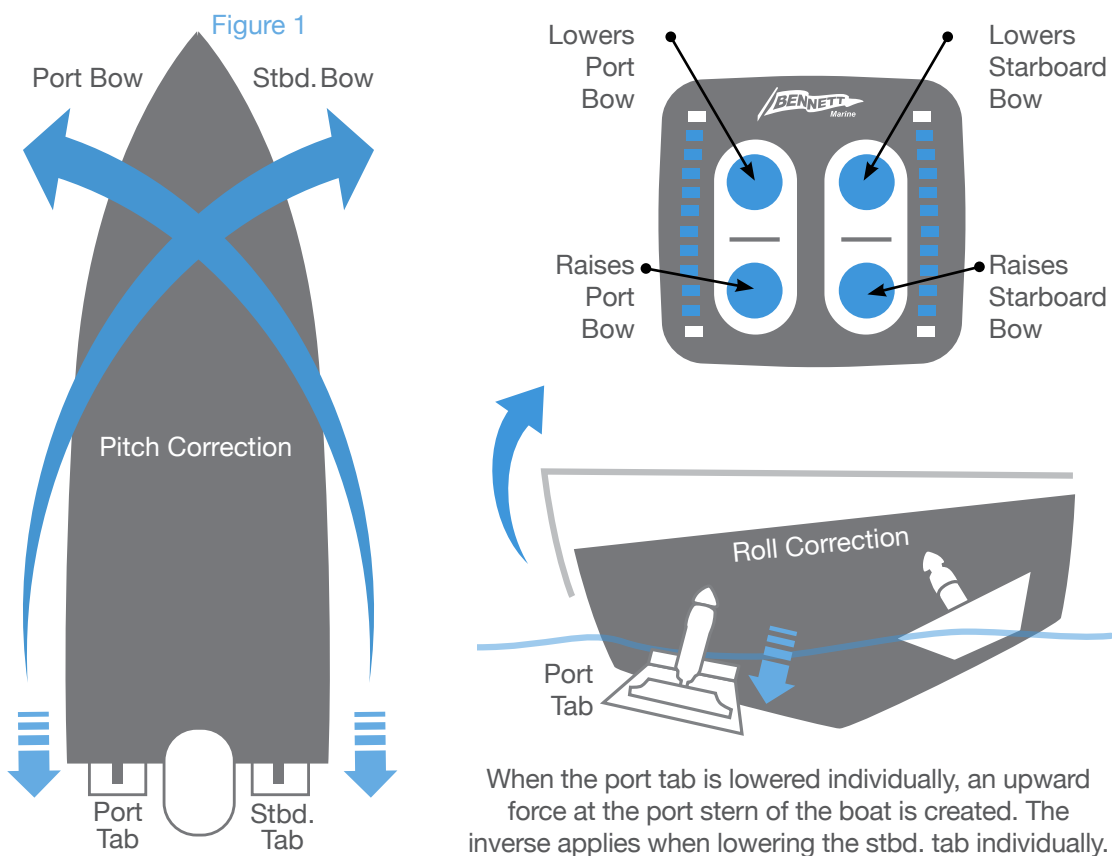

# Trim Tab Overview & Operation

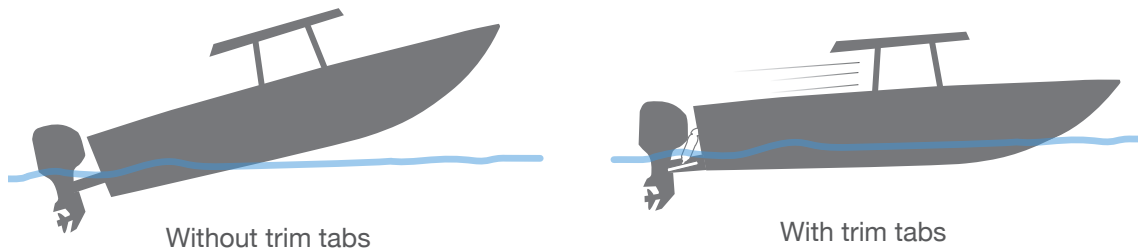

## Getting and staying trimmed

Most boats break over (get on plane) at a particular speed. This speed is determined by weight distribution, and water conditions, etc. Bennett's trim tabs enable your boat to plane at speeds lower than the natural planing speed. By pressing the control to the BOW DOWN position, your trim tabs move down. This will raise your stern and lower your bow, getting you up on plane faster.

## Optimum Attitude

A good way to find your boat's optimum attitude is to conduct this test. Run the boat lightly loaded, at full speed on flat water. Notice the bow in relation to the horizon. This should be your boat's best running attitude. Properly sized trim tabs can be used to recreate this optimum attitude regardless of weight distribution, speed or water conditions.

## Getting Used to the Feel of Your Trim Tabs

When learning to use your tabs, begin by pressing the helm control in half second bursts for gradual trimming. Be careful not to over-trim your boat. An over-trimmed boat will plow or bow-steer. If you over-trim the boat, simply press BOW UP and the bow of the boat will rise.

# Trim Tab Overview & Operation

## Special Conditions & Safety Precautions

### Correcting for a List

Bennett Trim Tabs may be operated individually so that you can correct for listing. Your control is designed so that you can use it intuitively. Do not think about what the trim tabs are doing, just concentrate on the bow. If the port bow is high, push the port side BOW DOWN direction. If the starboard bow is high, push the starboard side BOW DOWN direction. Press the control in half-second bursts to avoid over-trimming, allowing time between corrections for the boat to react.

### Using In Conjunction With Outboard Trim/Tilt

Using your trim tabs in conjunction with your engine's power trim will give you increased speed and power.

1. Adjust the trim tabs to achieve a planing attitude.
2. Use the power trim to position the prop path parallel to the water flow as indicated by increased RPM / Speed.
3. If necessary, re-adjust the trim tabs to fine tune the trim of your boat. In other words, use your trim tabs to trim the boat and your power trim to trim your prop.

### Running In Rough Water

When running in a chop or heavy seas, press BOW DOWN on both tabs. This will bring the "V" of the hull in contact with the waves rather than having the waves pound the hull and your passengers.

### Following Sea

For maximum control and maneuverability in a following sea or when running in an inlet, make sure the trim tabs are fully retracted by pressing BOW UP on both tabs. This brings up the tabs, decreasing lift in the stern, allowing the bow to rise. If tabs are deployed, the bow may dig.

### Windy Chop

To raise the windward side of the boat press BOW UP on that side. If this is not sufficient, press BOW DOWN on the leeward side of the boat. This allows the windward side of the boat to rise and minimizes spray. Do not overtrim when attempting this.

# Trim Tab Overview & Operation

## Shallow Water / Hole Shot

To lift the stern and lower the bow, lower both tabs completely down by pressing BOW DOWN on both tabs. As you throttle up and speed increases, raise the tabs by pressing BOW UP on both tabs.

## Porpoising

Porpoising is a condition more common in faster boats. As speed increases, the bow repeatedly rises out of the water until gravity overcomes lift and the bow falls down. Press “Bow Down” in half second bursts. As the trim tabs deflect, the porpoising subsides and your speed should remain the same or decrease. Only a slight amount of trim tab deflection should be necessary.

## Safety Precautions

Bennett trim tabs have a significant effect on the operation and versatility of your boat. No one knows your boat better than you, so the best learning method is to spend time getting familiar with your boat’s reaction to the trim tabs. Remember, practice makes perfect! As your experience increases, so will your enjoyment. Always operate your boat with safety first in mind.

- Do not over-trim, particularly at high speeds as the bow will dig in and wave action may cause the boat to veer.
- While operating trim tabs, use caution. Improper use of trim tabs may cause accidents and/or injury.
- For best maneuverability, trim tabs should be fully retracted in a following sea, or when running in an inlet.



# Installation Instructions

## Before Installation

- The actuator replacement must be done when the vessel is out of the water. Do not attempt to replace the actuators while the vessel is in the water as the actuators are mounted below the water line.
- Before performing any electrical work on a vessel, disconnect the battery by removing the positive (+) cable or if equipped, turning the battery disconnect switch to the OFF position.
- The Bennett hydraulic actuators should be fully retracted. If the cylinders have not been fully retracted, hydraulic fluid will leak out of the actuators as they are disconnected (since the actuators are spring loaded).

## Compatibility

This conversion kit is only for standard 12V Bennett Marine hydraulic trim tab systems with a standard rocker switch. Before you begin the conversion verify the following items:

- **Positioning Systems:** The system does not have any trim tab position indication. If the system was equipped with a Trimindicator, a TPI, and EIC, or a NEMA2000 indication system, the indication system will not function after the conversion to electric actuators. For indication with electric actuators a BCI8000 system needs to be purchased.
- **Actuator Size:** The Bennett hydraulic actuators have four bands around the bottom of the actuator. The four band actuators are standard Bennett actuators. Three band actuators are about 2" shorter and the electric actuators will not fit in this system.
- **Non-standard Bennett Actuators:** With the Bennett actuators fully retracted, the lower hinge will be about 1" from the bottom of the cylinder. If the distance is longer or shorter than 1", the actuators are non-standard OEM-specific Bennett actuators which are incompatible with this conversion kit.
- Verify that the rocker switch on the helm is a genuine Bennett rocker switch. A genuine Bennett rocker switch will have a Bennett burgee (flag) logo on the face of the switch.



Bennett embossed  
burgee (flag) logo



# Installation Instructions

## Planning the Installation

- The new electric system will replace the hydraulic pump with an electric relay module which is plug n' play, and will eliminate any need for switch rewiring.
- Verify that the motor extension cables supplied will reach from the relay module (pump) location to the actuators.
- Verify that the wire harness connector at the pump is a four position Mate-n-Lock type connector. If your pump uses a Deutsch waterproof type connector, contact Bennett Marine for an adapter.

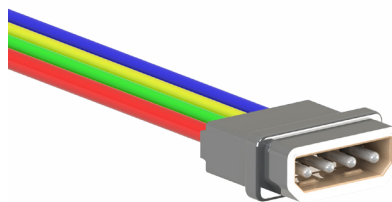

Mate-n-Lock connector

- If your vessel does not meet the meet any of the above requirements, please contact Bennett Marine directly at (954) 427-1400. We can provide you with assistance on converting to electric, or we can assist you with a simple repair of your hydraulic system.

## Removing the Pump

To remove the pump follow these steps:

- Disconnect the four position wire harness cable from the pump. This cable has red, green, yellow and blue wires twisted together to form the cable. Inspect the connector on the wire harness cable. If there are any signs of corrosion, contact Bennett Marine for a replacement.
- Disconnect the black ground wire from the pump. This wire can be cut close to the pump. The ground wire may be reused with the new electric actuators.
- Disconnect the hydraulic lines from the pump. Use a 1/2" wrench to loosen and remove the fittings from the pump. Put tape over the fitting ends to minimize any fluid loss from the lines.
- Loosen the four screws in the pump mounting bracket.
- Carefully lift the pump straight up out of the mounting bracket. Do not tip the pump over as hydraulic fluid may leak out of a pump that is laid on its side.

# Installation Instructions

- The pump is filled with hydraulic fluid. Take the pump to an oil recycling center to dispose of the hydraulic fluid.
- Completely remove the pump mounting bracket.

## Removing the Hydraulic Actuators

- Bennett Marine supplies actuators with two types of hydraulic connections. One will have pipe nipples that protrude through the transom, and one will have the tubing going straight into the transom with no fitting visible from the inside.

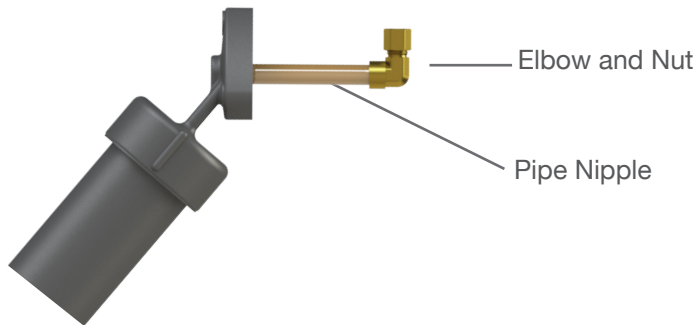

- If your vessel has pipe nipples:
  - » Remove the hydraulic tubing from the fitting on the pipe nipple by loosening the nut on the hydraulic tubing. The nut must be twisted until the tubing comes free.
  - » Using an adjustable wrench, remove and fittings from the pipe nipple. If the pipe nipple unscrews from the actuator at this time that is acceptable.
  - » Remove the fittings and tubing from the vessel. Tubing may be useful to pull wires through the hull.
- If your vessel does not have pipe nipples, the tubing will be removed from the outside of the vessel.
- On the outside of the boat, use a #2 Phillips screwdriver to disconnect the trim tabs from the hydraulic actuators by removing the two 1/4-20 pan head screws. The tabs should drop slightly away from the actuator.

# Installation Instructions

- Remove the actuators from the hull by unscrewing the three screws in the upper hinge using a #3 Phillip's screwdriver.
- Pull the actuator away from the hull to break the seal. If the actuators have pipe nipples, pull the actuators until the pipe nipples are completely out of the hull. If the vessel did not have pipe nipples, as the actuator is pulled the tubing will come with the actuator. When the actuator is far enough away from the hull to see the fitting, loosen the fitting with a 1/2" wrench. After the actuators are free, go back into the vessel and remove the tubing.
- The actuators and tubing are full of hydraulic fluid. Do not lay the actuators down or fluid will leak out of them. Take the actuators to a recycling center and dispose of the hydraulic fluid there. Once the fluid has been drained from the actuators, the plastic can be recycled. The actuators and the tubing are made from Nylon material.

## To Install the New BOLT Actuators

- Carefully insert the end of the electrical cable through the adjustable upper hinge mount and install the sealing grommet onto the cable.

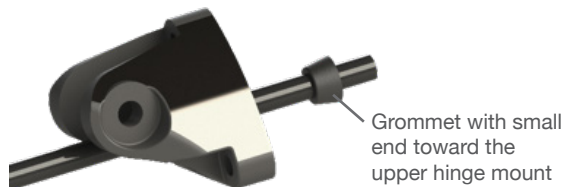

- Pull the cable through the mount until the mount is about 8" from the actuator.
- Insert the end of the cable through the transom hole.
- Temporarily mount the actuator to the adjustable upper hinge using the supplied 5/16-18 bolt and lock nut (using a 1/2" wrench) to set the cable length.

# Installation Instructions

- Temporarily mount the upper hinge of the new actuator to the transom using (2) of the supplied #14 x 1-1/2" screws in the lower mounting positions, leaving a gap of 1/4" between the upper hinge and the transom. Pull the excess cable through the transom leaving enough cable to prevent the actuator from binding during its normal movement.

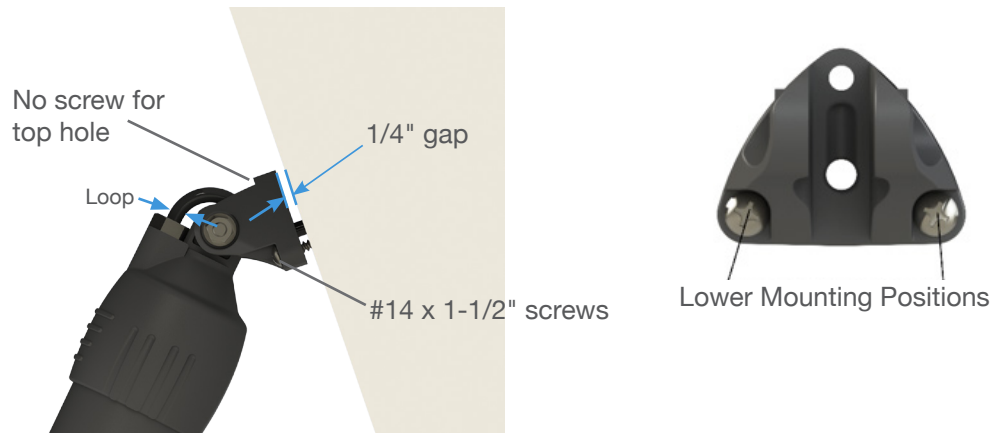

- Ensure that the cable sealing grommet is moved down the cable to its seat on the upper hinge.
- Swing the actuator through its maximum range of motion to ensure there is the proper amount of cable to allow movement without binding.



# Installation Instructions

- Unscrew the two #14 x 1-1/2" screws holding the adjustable upper hinge and pull back from the transom making sure the cable length does not change.
- Apply 3M 5200 waterproof sealant on the mounting surface and around the wiring of the new actuator.

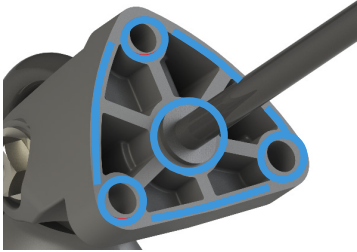

- Screw the adjustable upper hinge to the transom using (2) of the supplied #14 x 1-1/2" screws in the lower 2 mounting positions.

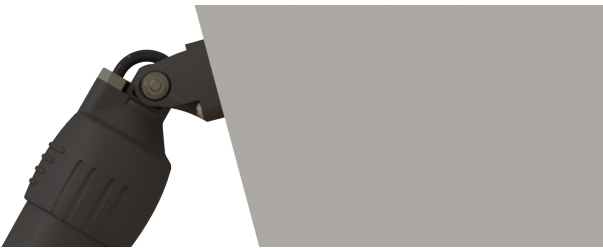

- Remove the BOLT actuator from the upper hinge allow the actuator hang.



- Install the remaining (1) #14 x 1-1/2" screw into the top position of the hinge.

# Installation Instructions

- Install the BOLT actuator to the upper hinge using the supplied 5/16-18 bolt and nut. Make sure not to over-tighten as the actuator needs to rotate within the hinge. Over-tightening will cause the actuator to bind. Do not collapse upper hinge mount uprights.
- Tighten until the bolt and nut contact the flanges of the upper hinge. There should be a gap between the uprights of the upper hinge mount and the flanges on the actuator.
- Install the lower hinge mount to the trim tab using the (2) supplied 1/4-20 x 3/4" screws and nuts using a 1/2" wrench and a #2 Phillips head screwdriver.



- Install the wiring connector onto the wires:
  - » Insert the black wire into location pin #1, insert the white wire into location pin #2 one at a time into the back of the connector until the pin locks into place.
  - » Ensure the proper wire color is on the correct side of the connector by comparing the old connector that was cut off.
  - » Install the orange plastic wedge retainer into the front of the connector.

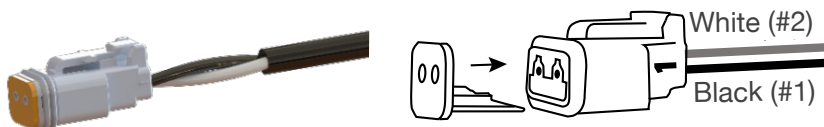

# Installation Instructions

- Connect the male wiring connector to female wiring connector coming from the relay module. For help with connectors visit [Youtu.be/LIR9-ZdG958](https://youtu.be/LIR9-ZdG958).
- Reconnect the positive (+) battery cable or turn battery disconnect switch to the ON position and check the system for functionality.
- Troubleshooting: If the actuators are working backwards, the wires are reversed.

## Installing the Relay Module

- The Bennett Maine Conversion Kit relay module has been designed to simplify all the wiring required on your new electric actuator system.
- Locate the ideal mounting location for the relay module. Primarily a dry location that is easily reached by the wire harness from the original hydraulic system, as well as by both of the electric actuator cables.
- Mount the relay module using the two #8 x 3/4" screws provided.
- Plug the wire harness connector from the existing harness into the mating input cable on the relay module.
- Plug the port actuator cable into the port cable on the relay module. The port cable on the relay module will have a red band next to the connector.
- Plug the starboard actuator cable into the port cable on the relay module. The starboard cable on the relay module will have a green band next to the connector.
- Connect the purple wire to the ignition. This wire is used to signal the system that the ignition is on or off. This wire needs to receive 12V anytime that the ignition is turned ON, and 0V when the ignition is turned off. With this wire connected, the tabs will automatically retract anytime the ignition is turned off to prevent damage to the tabs.
- Connect the black ground wire from the relay module to the black ground wire that was connected to the back of the pump. Run an orange wire from the switch power to the orange wire of the relay module or use a suitable alternate 20A power source. The power source should be disconnected when the batteries are turned off.



## Testing the system

- Reconnect the battery to the electrical system or turn “on” the disconnect switch.
- Press the helm rocker switch on the Starboard side in the BOW DOWN Direction.
  - » The port tab should extend.
- Press the helm rocker switch on the Port side in the BOW DOWN Direction.
  - » The starboard tab should extend.
- Press the helm rocker switch on the Starboard side in the BOW UP Direction.
  - » The port tab should retract.
- Press the helm rocker switch on the Starboard side in the BOW UP Direction.
  - » The starboard tab should retract.
- Press the port and starboard rocker switches in the BOW DOWN direction.
- Turn the ignition on for about 15 seconds.
- Turn the ignition off.
  - » Both tabs should fully retract.

## Troubleshooting

- If the system is working properly the following LEDs will illuminate on the Relay Module:
- If power is ON to the system:
  - » Red LED at the top of the unit will be illuminated.
  - » If no red LED, check the fuse, check circuit breakers, and check ground wire.
  - » No other LEDs will work until the red LED is illuminated.
- Press the helm rocker switch on the starboard side in the “Bow Down” direction.
  - » On the relay module the red and blue input LEDs should illuminate, and the blue LED on the port actuator output should illuminate.

# Testing & Troubleshooting

- » If the red and blue LEDs do not both illuminate, check the connector, check the switch wiring, insure that all of the screws are on the back of the rocker switch.
- » If the port actuator blue LED comes on, but the port actuator does not deploy, check the actuator connector pins to insure that the pins did not push back.
- Press the helm rocker switch on the port side in the “Bow Down” Direction.
  - » On the relay module the green and blue input LEDs should illuminate, and the blue LED on the stbd. actuator output should illuminate.
  - » If the green and blue LEDs do not both illuminate, check the connector, check the switch wiring, insure that all of the screws are on the back of the rocker switch.
  - » If the Stbd. actuator blue LED comes on, but the stbd. actuator does not deploy, check the actuator connector pins to insure that the pins did not push back.
  - » If the actuator extends, the wires at the actuator are revealed. Remove from waterproof connector and switch. For help with connectors visit [Youtu.be/LIR9-ZdG958](https://youtu.be/LIR9-ZdG958).
- Press the helm rocker switch on the starboard side in the BOW UP direction.
  - » On the relay module the red and yellow input LEDs should illuminate, and the yellow LED on the port actuator output should illuminate.
  - » If the green and blue LEDs do not both illuminate, check the connector, check the switch wiring, insure that all of the screws are on the back of the rocker switch.
  - » If the port actuator yellow LED comes on, but the port actuator does not retract, check the actuator connector pins to insure that the pins did not push back.
  - » Press the helm rocker switch on the Starboard side in the BOW UP Direction.
  - » On the relay module the Green and Yellow input LEDs should illuminate, and the Yellow LED on the Stbd actuator output should illuminate.

# Testing & Troubleshooting

- » If the Green and Yellow LEDs do not both illuminate, check the connector, check the switch wiring, insure that all of the screws are on the back of the rocker switch.
- Press the helm rocker switch on the port side in the BOW UP direction.
  - » On the relay module the green and yellow input LEDs should illuminate, and the yellow LED on the stbd. actuator output should illuminate.
  - » If the green and blue LEDs do not both illuminate, check the connector, check the switch wiring, insure that all of the screws are on the back of the rocker switch.
  - » If the port actuator yellow LED comes on, but the port actuator does not retract, check the actuator connector pins to insure that the pins did not push back.
  - » Press the helm rocker switch on the Starboard side in the BOW UP Direction.
  - » On the relay module the Green and Yellow input LEDs should illuminate, and the Yellow LED on the Stbd actuator output should illuminate.
  - » If the Green and Yellow LEDs do not both illuminate, check the connector, check the switch wiring, insure that all of the screws are on the back of the rocker switch.
- If the Stbd actuator Yellow LED comes on, but the Stbd actuator does not retract, check the actuator connector pins to insure that the pins did not push back
- Press the Port and Starboard rocker switches in the BOW DOWN direction.
  - » The Red, Green, and Blue input LEDs should come on during this operation. The BLUE output LEDs for both actuators should come on.
- Turn the ignition on for about 15 seconds.
- Turn the ignition off.
  - » Both Yellow output LEDs should come on as the tabs retract.
  - » If the auto tab retraction is not working, check the voltage of the purple wire. Insure that there is 12V while the ignition is on, and zero when the ignition is turned off.

# Bennett Marine Warranty

*(United States Only)*

We at Bennett Marine, (Bennett) are committed to product quality and customer satisfaction. We've supported our products for more than half a century and have earned a reputation for exceptional service and support. In keeping with that tradition Bennett provides a Limited Warranty for its Products. Please see the table on page 32 for our Warranty details.

## Limited Warranty:

Bennett warrants to the original purchaser and subsequent owners, that Bennett will repair or replace, at the discretion of Bennett, any part or component manufactured by Bennett which is proven to the satisfaction of Bennett to be defective, and which failure has occurred under normal use and within the warranty period. This Limited Warranty does not apply to products that have been damaged, or which fail, as a result of causes other than manufacturing defects (such as but not limited to electrical overloads, electrolysis, casualty, fire, collision, improper installation, lack of maintenance, exposure to elements, alteration, or misuse). This warranty does not cover damage to finishes. The warranty commences from the first date a product is purchased by the customer. If the product is installed on a boat by an OEM then the warranty commences on the first day on which the first retail customer purchases the boat. This warranty applies exclusively to products purchased and used in the United States.

## Disclaimer And Exclusion Of Warranties:

**This warranty is meant to be a complete and exclusive statement of the terms of all express warranties offered by Bennett. To the extent permitted by law, there are no warranties, express or implied, including any implied warranties of merchantability or fitness for a particular purpose extended by Bennett other than the express warranty set forth in this instrument. Some states do not allow the exclusion of, or limitations to, implied warranties so the above limitation may not apply to you.**

## Warranty Claim Procedure:

To make a claim please call Bennett Marine at 954-427-1400 to trouble-shoot the issue and start the claim process. You will be asked to complete a form that can be found online at [BennettTrimTabs.com/Warranty](http://BennettTrimTabs.com/Warranty) and return the part for warranty evaluation. Parts will be evaluated upon receipt and any part found to meet the above warranty criteria will be repaired or replaced at Bennett's option. Replacement or repaired part will be shipped at no cost to customer via ground freight to US destinations only. Any expedite methods will be at customers expense.

## Transferability:

Before expiration of the warranty period, this Limited Warranty is fully transferable to subsequent owners of the boat on which it is originally installed and is void if the product is removed and reinstalled on another boat or is used for purposes for which it was not originally purchased.

# Bennett Marine Warranty

## Limitation And Exclusion Of Remedies:

Bennett's sole responsibility shall be the repair or replacement, at its option, of any defective part or component. In certain instances Bennett reserves the right to provide refurbished parts. Customer agrees that this is the sole and exclusive remedy under this Limited Warranty. Bennett will not be responsible for any incidental, consequential or indirect damages, including loss of use as a result of any manufacturing defect in a product. Bennett will not be responsible for labor, haul out, or any other fees associated with the removal or installation of warranted part. Some states do not allow the exclusion or limitation of incidental or consequential damages, so this limitation may not apply to you.

## Product modification:

Bennett reserves the right to change, modify or improve the products without obligation to incorporate such changes in products previously sold or installed. With respect to components or products replaced under this warranty, Bennett Marine reserves the right, in its sole discretion, to provide updated or current model components or products.

## Warranty Period For Bennett Products

PRODUCT	WARRANTY PERIOD	COMMENCEMENT DATE
<b>Bolt Electric Actuator</b>	Limited Lifetime	Purchased after 9/1/15
<b>Classic Hydraulic Actuator</b>	Limited Lifetime	Purchased after 9/1/15
<b>Premier Stainless Steel Actuator</b>	3 years	Purchased after 9/1/15
<b>Stainless Steel Hatch-lifters</b>	3 years	Purchased after 9/1/15
<b>Classic Hydraulic Pump</b>	5 years	Purchased after 9/1/15
<b>Control Switches</b>	3 years	Purchased after 9/1/15
<b>Electronic Indicator Control</b>	3 years	Purchased after 9/1/15
<b>Auto Tab Retractor</b>	3 years	Purchased after 9/1/15
<b>Auto Tab Control</b>	3 years	Purchased after 9/1/15
<b>Relay Modules</b>	3 years	Purchased after 9/1/15
<b>Tab Gauges</b>	3 years	Purchased after 9/1/15
<b>NMEA Systems</b>	3 years	Purchased after 9/1/15

\*\*\*Please note, products not listed on the above table are not covered under Bennett's Limited Warranty.

\*\*\*Limited Lifetime Warranty refers to the life of the product, not the boat, or the owner. Limited Lifetime Warranty ends when the product becomes unusable for reasons other than manufacturing defects.

## Return Procedure For Customers Outside Us:

For international returns, please refer to our worldwide distributor map on our website [BennettTrimTabs.com/find-a-dealer](http://BennettTrimTabs.com/find-a-dealer) to contact your local Bennett Marine distributor for warranty and returns procedures in your respective country.



**Bennett Marine, Inc.**

550 Jim Moran Boulevard, Deerfield Beach, FL 33442, USA



**954-427-1400**

M-F 8am to 5pm (EST)



[BennettTrimTabs.com](http://BennettTrimTabs.com)



**FAX**  
954-480-2897

[Info@BennettTrimTabs.com](mailto:Info@BennettTrimTabs.com)

Download your owners instruction manual at  
**[BennettTrimTabs.com/HYDBOLTCON-Install](http://BennettTrimTabs.com/HYDBOLTCON-Install)**

Or   
scan this

